

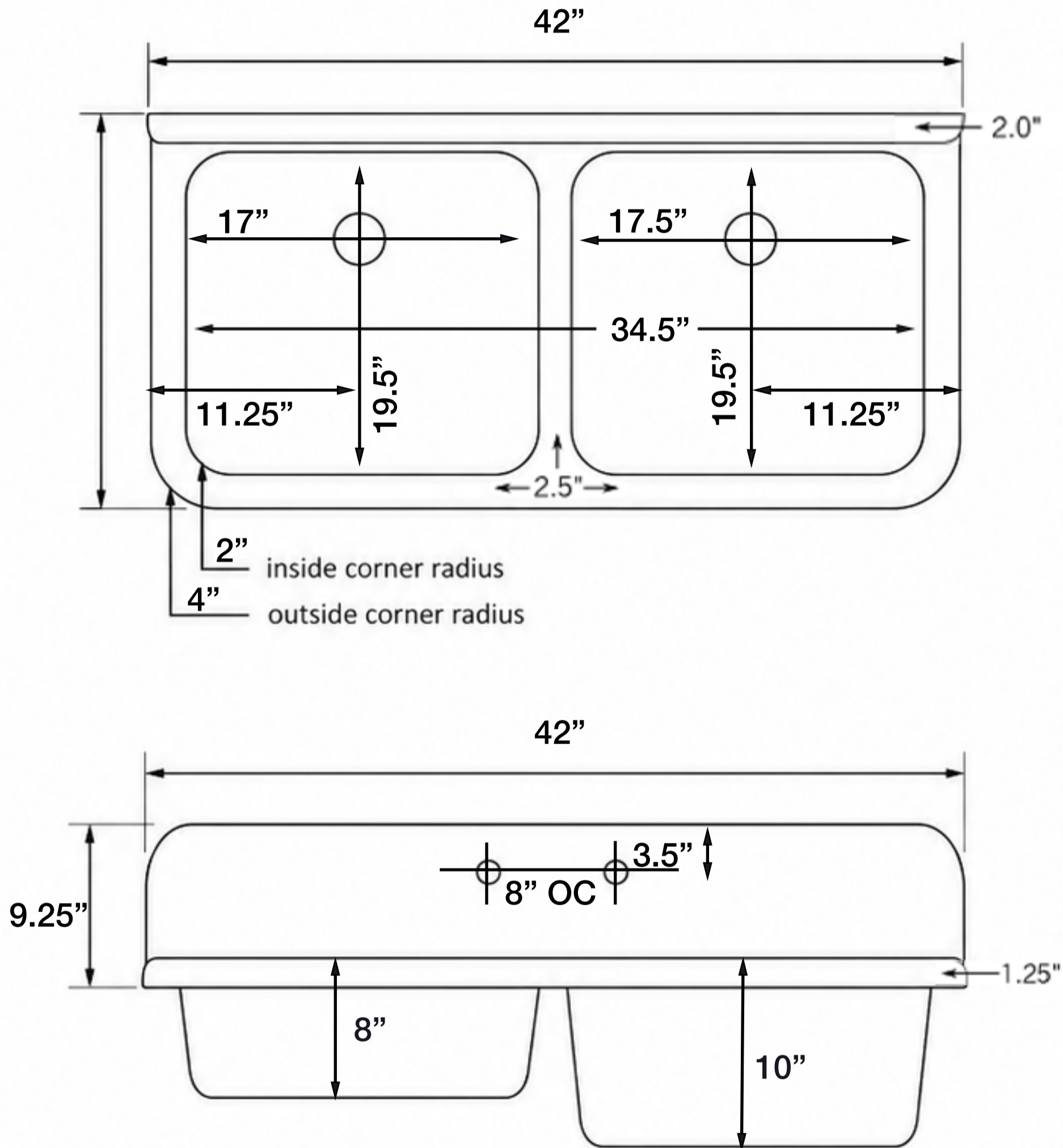

Double Basin Sink DBR4224



SPECIFICATIONS

Installation type: Top-mount

Faucet hole spacing: 8" OC

Faucet hole diameter: 1 3/8"

Drain hole diameter: 3.5"

www.nbidbs.com

All designs and specifications are subject to change without notification. All measurements are $\pm \frac{1}{4}$ "